



## **Manual for the Feathering Propeller**

### **DF-310 & DF-380 4 blade model**

Installation on the shaft	page 2
Operation	page 4
Pitch adjustment LH ( left-hand rotation propeller )	page 5
Pitch adjustment RH ( right-hand rotation propeller)	page 6
Defining and checking adjustments	page 7
Removing from the shaft	page 8
Servicing	page 9
Torque settings prop-nut	page 10
DNV-GL Certificate 2021 for Variprop feathering propeller	page 11 - 14

# INSTALLATION on the shaft

**The VARIPROP is delivered assembled, greased and ready for installation.**

**He may not be disassembled, otherwise the warranty claim goes out!**

Before fitting the VARIPROP onto the shaft, check key and keyway in the propeller hub. Take care that the key is the proper dimension and that the hub slides completely onto the shaft (see below). Also check the nut on thread of the shaft before fitting the prop. If you can not screw the nut the complete length of the thread, because of a little damage to the thread, carefully use a triangle file to bring it down to a good fit.

Remove the housing cap with zinc anode (2) and the nut (4). Fit the propeller onto the shaft strongly. Tighten the nut (4) with LOCTITE medium (blue) onto the shaft ( torque-setting see page 10 ) and secure it with the lock pins (3). Fit the housing cap with anode (2).

Make sure that the propeller is always protected from electrolytic corrosion by changing the anode (2) latest every year! May not be necessary in freshwater. After the VARIPROP has been fitted properly check that the blades rotate freely from the forward stop to the reverse stop. The shock absorber function can be felt ! See servicing page 9.

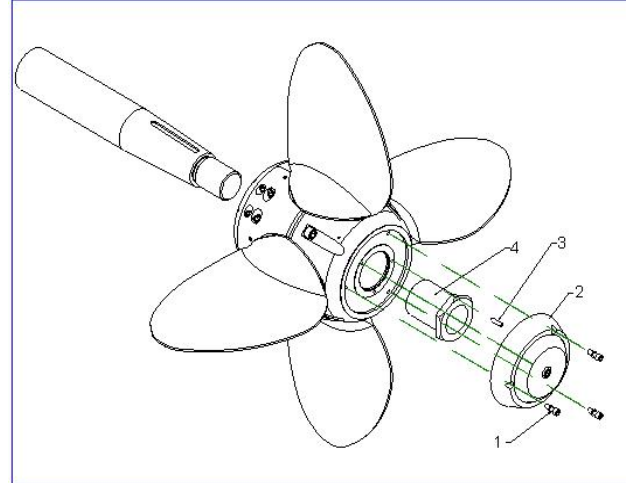

**BLUE FIT CHECK of PROPELLER:** The propellers are manufactured to close tolerances and therefore care must be taken when handling and mounting. Prior to mounting it may be necessary to check the blue fit of the propeller to guarantee a close fit to taper size. If the blue fit is unsatisfactory due to temperature differences it may be necessary to ream the propeller to suit. Therefore please use the grinding paste supplied with the propeller.

It must be noted however that all blue fits will have been 70 to 80% of the taper length.

**MOUNTING:** First slide the prop on the shaft without key. Mark the shaft with a grease-pen at the prop end. After tightening the shaft nut very strongly ( torque-setting see page10 ) the mark must disappear. If not, the key is binding and the top or the sides of the key must be filed down. Light must be shining through on the top of the key when looking into the hub from astern. You may have to move your eye vertically to see it.

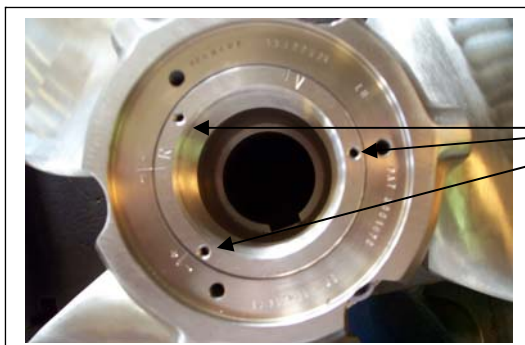

**Only two** of the three lock-pin holes can be used, depending on the final position of the shaft-nut flange ( 3 ).

Carefully align the lock-pins (3) straight. They must go in easily. If not, try first to tighten the propnut a little further until they do. If impossible, back off the nut a little. The lock-pins should be hand tightened only. If overtightened they may strip.

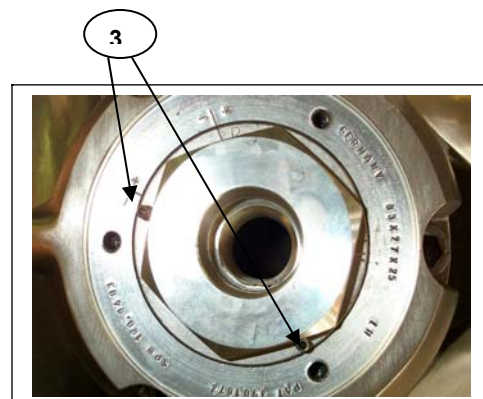

# **INSTALLATION on the shaft**

## **ATTACHING THE HOUSING CAP with ZINC-ANODE:**

First, insert all three housing cap screws (1, also page 8) loosely, then tighten securely in succession. Use LOCTITE low (pink) and observe the little washers.

## **ENGINE DRY TEST:**

Please consider that a dry test of the engine **MUST NOT** be done while the VARIPROP is fitted onto the shaft ! The VARIPROP needs water pressure on the blades, otherwise the prop could be damaged !!

# OPERATION

The VARIPROP feathers automatically when the shaft rotation is stopped. After engine start-up and shifting into gear the blades will engage in either forward or reverse.

## THE BEST WAY TO FEATHER THE PROPELLER IN THE SAILPOSITION IS:

### VARIPROP sailposition with mechanical gear-box:

- Power at 3 to 4 knots in forward.
- **Stop the engine, turn it off** and engage the transmission in reverse to stop the freewheeling of the shaft. Now engage in neutral again.

### VARIPROP sailposition with hydraulic transmission:

- Power at 3 to 4 knots in forward.
- Stop the engine while still engaged in forward. The remaining oil pressure of the transmission will stop spinning the shaft to feather the blades in the sailposition.

If the propeller is not feathered in the sailposition the shaft will freewheel like with a fixed propeller.

In that case start the engine again and repeat the steps above.

Once the prop is feathered, it is better to shift the transmission to neutral.

**DO NOT stop** the engine while it turns in reverse. In this case the blades will stay in the reverse position and will not feather. You can actually use this feature to drive a shaft generator.

***Please note that 98% of our delivered VARIPROP propellers for hydrolic gear boxes feather into sailing position without a shaft lock as you turn off the engine with forward gear still clutched in. This procedure generates higher oil pressure and prevents shaft rotation. This small-scale friction is usually enough to feather the propeller instantly into sailing position. If this procedure does not work, you most likely need to fit a shaft lock. For large yachts, equipped with a propeller from our VARIPROP XLS range, we highly recommend to fit a shaft lock to ensure the propeller feathers and stays in sailing position.***

**TROUBLE SHOOTING:** If the propeller does not work in forward or reverse go systematically through the points below:

- Check low idle of the engine. It should be at 400 to 600 rpm in idle.
- Check shifting movement of the transmission lever. Make sure that the shifting travel is not too short. The amount of lever travel, as measured at the pivot point of the actuating lever, between the neutral position and end positions for forward and reverse can be found in the owners manual of your transmission. A larger amount of lever travel is in no way detrimental.
- Check the clutch discs of the transmission. They could be worn out.

**WARNING:** It is important to follow the instructions below carefully so as to avoid excessive load and shock to the gears, shortening their life.

- When going from ahead to astern or the opposite, it is necessary to idle down and shift at low rpm's (**max. shaft speed 120-150rpm**) between gears to allow smooth reversing of rotation without binding. This will substantially lengthen the service life of your propeller gears.
- When going from ahead to astern or the opposite, you can hear the turning-noise of the feathering blades. This is normal and not a problem or a defect of your VARIPROP. The propeller body must always be completely filled with a high viscosity grease. We recommend synthetic grease typ TW.2 GEL or mineral multi-purpose grease EP/SAL 8 (see servicing page 9 )
- The propeller must be protected from electrolytic corrosion by fitting the usual zinc anodes on the shaft plus the prop anode. We recommend the replacement of the anode once a year.
- If you want to protect your VARIPROP with Antifouling, use only Antifouling which needs a primer first. Otherwise chemical interaction and decomposition could occur. Our recommendation is *Velox TF* including a primer ( offers also protection against electrolyses ), available from your VARIPROP distributor.

# PITCH ADJUSTMENT „LH“

**GENERAL:** The pitch adjustment is very simple on the VARIPROP, and can be done in or out of the water in a matter of few minutes. It is not necessary to pull the propeller from the shaft.

Propeller in the drawing below is for a left hand rotation VARIPROP LH.

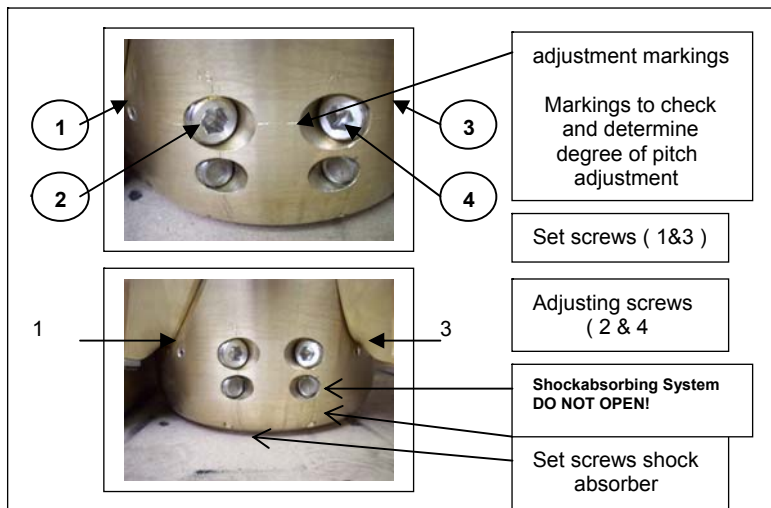

AH (Ahead)  
AS (Astern)

**NOTE:** It is quite possible to set the pitch continuously variable and independently for forward and reverse. The turning of the adjusting screws (2) & (4) by quarter a revolution (90°) changes the pitch approx. 1.5". This will change the engine revolution by approx. 175 rpm.

**ATTENTION:** **Never** remove the set screws of the shock absorber !!

The following description refers to the view towards astern for a left hand VARIPROP.

## **A. Adjusting the forward pitch:**

1. Remove the set screw (1) 4\* or 5mm allen key). Under water: only 3 turns loosen.
2. Turn the adjusting screw (2) which is marked as "AH" with the 12\* or 14mm Allen-key as follows:

### **2a. Increasing of pitch approx. 9" max.:**

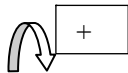

- Turn the adjusting screw (2) clockwise. ( see "NOTE" above and page 7)
- Secure set screw (1) with LOCTITE low (pink) Lock set screw strongly.

### **2b. Reducing of pitch approx. 6" max.:**

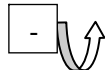

- Turn the adjusting screw (2) anti-clockwise. ( see "NOTE" above and page 7).
- Secure set screw (1) with LOCTITE low (pink)
- Lock set screw strongly.

## **B. Adjusting the reverse pitch:**

1. Remove the set screw (3) 4\* or 5mm allen key). Under water: only 3 turns loosen.
2. Turn the adjusting screw (4) which is marked as "AS" with the 12\* or 14mm Allen-key as follows:

### **2a. Increasing of pitch approx. 9" max.:**

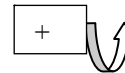

- Turn the adjusting screw (4) anti-clockwise. ( see "NOTE" above and page 7)
- Secure set screw (3) with LOCTITE low (pink) Lock set screw strongly.

### **2b. Reducing of pitch approx. 6" max.:**

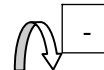

- Turn the adjusting screw (4) clockwise. ( see "NOTE" above and page 7).
- Secure set screw (3) with LOCTITE low (pink).
- Lock set screw strongly.

**Mark \***  
**\* DF-310**

# PITCH ADJUSTMENT „RH“

**GENERAL:** The pitch adjustment is very simple on the VARIPROP, and can be done in or out of the water in a matter of few minutes. It is not necessary to pull the propeller from the shaft.

Propeller in the drawing below is for a right hand rotation RH.

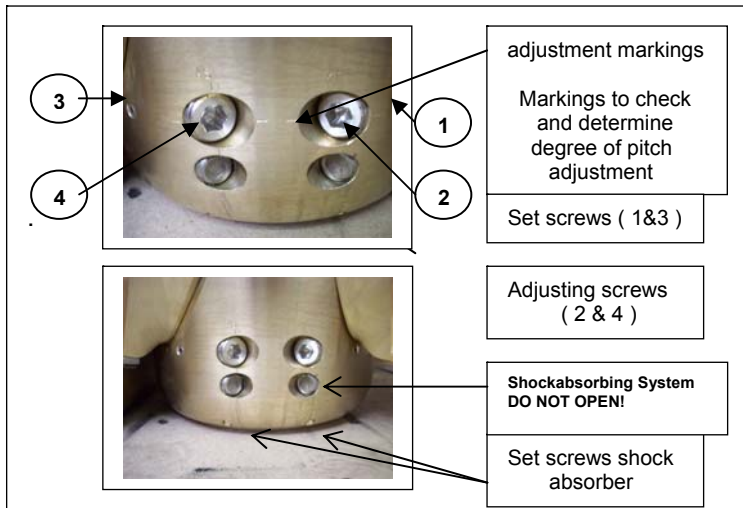

AS (Asterm)  
AH (Ahead)

**NOTE:** It is quite possible to set the pitch continuously variable and independently for forward and reverse. The turning of the adjusting screws (2) & (4) by quarter a revolution (90°) changes the pitch approx. 1.5". This will change the engine revolution by approx. 175 rpm.

**ATTENTION:** Never remove the set screws of the shock absorber !!

The following description refers to the view towards astern for a right hand VARIPROP.

## A. Adjusting the forward pitch :

1. Remove the set screw (1) 4\* or 5mm allen key). Under water: only 3 turns loosen.
2. Turn the adjusting screw (2) which is marked as "AH" with the 12\* or 14mm Allen-key as follows:

### 2a. Increasing of pitch approx. 9" max.:

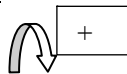

- Turn the adjusting screw (2) clockwise. ( see "NOTE" above and page 7)
- Secure set screw (1) with LOCTITE low (pink).
- Lock set screw strongly.

### 2b. Reducing of pitch approx. 6" max.:

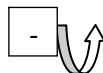

- Turn the adjusting screw (2) anti-clockwise. ( see "NOTE" above and page 7).
- Secure set screw (1) with LOCTITE low (pink).
- Lock set screw strongly.

## B. Adjusting the reverse pitch :

1. Remove the set screw (3) 4\* or 5mm allen key). Under water: only 3 turns loosen.
2. Turn the adjusting screw (4) which is marked as "AS" with the 12\* or 14mm Allen-key as follows:

### 2a. Increasing of pitch approx. 9" max.:

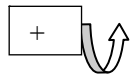

- Turn the adjusting screw (4) anti-clockwise. ( see "NOTE" above note and page 7)
- Secure set screw (3) with LOCTITE low (pink).
- Lock set screw strongly.

### 2b. Reducing of pitch approx. 6" max.:

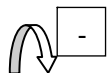

- Turn the adjusting screw (4) clockwise. ( see "NOTE" above and page 7).
- Secure set screw (3) with LOCTITE low (pink).
- Lock set screw strongly.

**Mark \***  
**\* DF-310**

## Defining and checking pitch adjustments

It is quite possible to set the pitch continuously variable and independently for forward and reverse. The turning of the adjusting screws (2) & (4) at pages 5 & 6 by quarter a revolution ( 90° ) changes the pitch approx. 1.5 “.

For a check of pitch adjustments there are markings on the hub face under the housing cap.

To return to original factory pitch settings, line up “AH” or “V” resp. “AS” or “R” markings on the hub face.

### Example:

#### check adjustments ahead

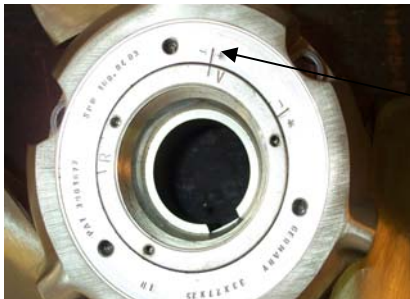

markings  
line up

original factory pitch setting  
ahead

#### inner marking has moved

plus



pitch has been increased ahead

#### check adjustments astern



markings  
lined up

original factory pitch setting  
astern

#### inner marking has moved

minus



pitch has been decreased astern

### NOTE :

- If the engine does not reach the desired RPM reduce the pitch.
- If the engine exceeds the desired RPM increase the pitch.
- 1.5” of pitch reduction / increase results in approx. 175 engine revolutions increase / reduction.

# VARIPROP REMOVAL



The puller system is delivered with the VARIPROP.  
The system includes only two parts :

- (1) The puller nut and
- (2) the hexagonal head bolt



- 1.) In order to remove the VARIPROP you must first remove the housing cap with zinc anode.
- 2.) Remove both lock pins (3,page 2) and the prop nut (4,page 2)



- 3.) Screw the puller nut **completely** into the hub



- 4.) Now screw the hexagonal head bolt into the nut and turn the bolt against the shaft until the VARIPROP comes off the taper.  
Never use a hammer to remove the prop from the taper !

**NOTE :** Never dismantle the VARIPROP yourself !!  
Disassembly and reassemble require special tools and technical know-how only available at the factory or their approved service centres.



# SERVICING

The VARIPROP needs to be greased up a minimum of every 2 – 3 years, depending on the engine hours run, or whenever the boat is hauled. The VARIPROP body should always be completely filled with a high viscosity **grease** of a hydrophobic nature. Remove the cap screw (5) and screw in the lubricating nipple which is supplied with the tools. Remove the “grease out” screw (6). During filling with grease rotate the propeller from forward stop to reverse stop to allow the grease to work through the propeller. Stop to pump when grease comes out at the opened “grease out” port.

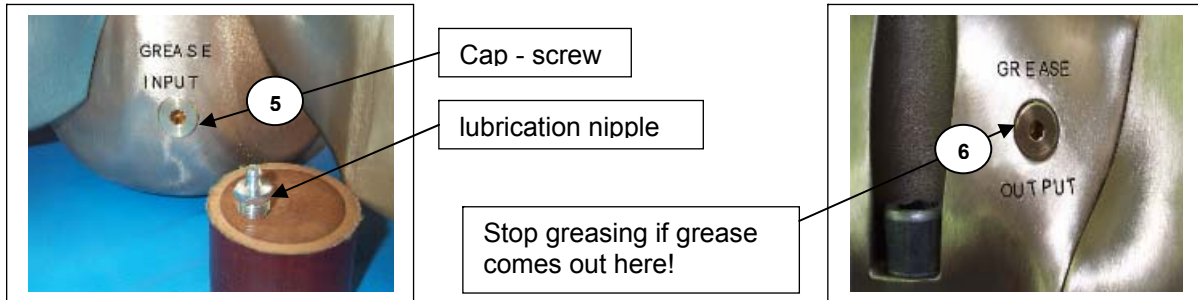

Factory supplied special grease EP/SAL is recommended and available from your VARIPROP distributor.  
**Avoid regular white grease (sterntube-grease) !**

**Zinc anode:** Make sure that you always keep the zinc anode in good condition. The VARIPROP must be protected by a lot of zinc, so also use a zinc anode onto the shaft if possible. Use fine sandpaper to clean the aft of the end boss and the forward face of the Variprop-anode to give the zinc good contact with the propeller.

## Tools supplied with your VARIPROP DF-310:



1x Manual  
1x puller system  
1x allen key 4mm  
1x allen key 6mm  
1x allen key 8mm  
1x allen key 8mm  
1x grease nipple G1/4"  
1x small plastic bottle with Loctite low (pink)

# Torque settings for the prop-nut

( page2, Fig.1, part-no.4 )

## Standard – thread

M 20 x 2,5 BSW 3 / 4 " – 10 UNC 3 / 4 " - 10	125 Nm / 95 ft/lb
--	-------------------

UNC 7 / 8" - 9	160 Nm / 115 ft/lb
----------------	--------------------

M 24 x 3 BSW 1 " - 8 UNC 1 " - 8	210 Nm / 155 ft/lb
--	--------------------

M 27 x 3	315 Nm / 230 ft/lb
----------	--------------------

M 30 x 3,5 BSW 1 1/8" – 7 UNC 1 1/8" - 7	350 Nm / 255 ft/lb
--	--------------------

UNC 1 1/4" – 7 RSW 1 1/4" - 7	350 Nm / 255 ft/lb
----------------------------------	--------------------

UNC 1 1/2" - 6 UNC 1 3/4" - 5	390 Nm / 290 ft/lb 550 Nm / 410 ft/lb
----------------------------------	--

## Fine - thread

M 20 x 1,5 BSF 3 / 4 " – 12 UNC 3 / 4 " - 16	135 Nm / 100 ft/lb
--	--------------------

M 24 x 2 BSF 1 " - 10 UNF 1 " - 12	225 Nm / 165 ft/lb
--	--------------------

M 30 x 2	430 Nm / 315 ft/lb
----------	--------------------

M 36 x 3	490 Nm / 360 ft/lb
----------	--------------------

M 42 x 3 M 56 x 4 M 64 x 4 M 85 x 6	530 Nm / 390 ft/lb 865 Nm / 635 ft/lb 975 Nm / 715 ft/lb 1250 Nm / 920 ft/lb
--	---

SUBJECT TO TECHNICAL ALTERATIONS; ERRORS and MISPRINTS

**TYPE APPROVAL CERTIFICATE****This is to certify:****That the Controllable Pitch Propeller**

with type designation(s)

**Feathering Propeller series VP, GP, DF**

Issued to

**S.P.W. GmbH Sail Propeller- und Wellenbau  
Bremerhaven, Germany**

is found to comply with

**DNV GL rules for classification – Ships****DNV GL rules for classification – Yachts****DNV GL rules for classification – High speed and light craft****Application :****Product(s) approved by this certificate is/are accepted for installation on all vessels classed  
by DNV GL.**Issued at **Hamburg** on **2021-02-16**for **DNV GL**This Certificate is valid until **2026-02-15**.DNV GL local station: **Hamburg – CMC North/East**Approval Engineer: **Olaf Richter****Olaf Drews  
Head of Section**

This Certificate is subject to terms and conditions overleaf. Any significant change in design or construction may render this Certificate invalid. The validity date relates to the Type Approval Certificate and not to the approval of equipment/systems installed.

LEGAL DISCLAIMER: Unless otherwise stated in the applicable contract with the holder of this document, or following from mandatory law, the liability of DNV GL AS, its parent companies and subsidiaries as well as their officers, directors and employees ("DNV GL") arising from or in connection with the services rendered for the purpose of the issuance of this document or reliance thereon, whether in contract or in tort (including negligence), shall be limited to direct losses and under any circumstance be limited to 300,000 USD.



## Product description

Feathering propellers

## Application/Limitation

For sailing ship propulsion.

Type	Blades	Propeller diameter max. [mm]	Engine power max. [kW]	Propeller torque max. [Nm]	Propeller speed max. [rpm]
VP-64	2, 3	455	22	150	1400
VP-76	2, 3	560	55	375	1400
VP-104	3	660	82	653	1200
DF-80, GP-80	2, 3, 4	432	22	150	1400
DF-107, GP-107	2, 3, 4	508	59	402	1400
DF-112, GP-112	3, 4	635	88	700	1200
DF-128	3, 4	715	103	894	1100
DF-140	3, 4	762	132	1261	1000
DF-160	3	864	202	2030	950
DF-180	3	914	257	2727	900
DF-190	4	864	202	2030	950
DF-210	4	914	257	2727	900
DF-230	3	1016	308	3676	800
DF-260	4	1016	308	3676	800
DF-280	3	1270	404	5144	750
DF-310	4	1270	404	5144	750
DF-380	4	1575	550	12500	750

## Type Approval documentation

Drw No	Rev	Title	Status
-	2020-11-21	Drawing list VP64	DI Discarded**
-	2020-11-21	Drawing list GP112	DI Discarded**
-	2010-01-19	Document List of VariProfile	DI Discarded**
-	-	DF-380 part list	DI Discarded**
-	-	Material data propeller hub	FI For Inf.
-	-	Propeller assembly	DI Discarded**
-	-	Variprofile Broschüre	DI Discarded**
-	2020-11-21	Drawing list VP76	DI Discarded**
-	-	Blade sections DF-xx 12-50"	AP Approved
-	-	Variprop brochure	DI Discarded**
-	-	Assembly drawings + blade sections DF-xx	AP Approved
Anode DF-380	01	Anode DF-380	DI Discarded**
Anode VP104-02	01	Anode VP-104	DI Discarded**
Anode VP64-02	04	Anode / VP-64	DI Discarded**
Anode VP76-02	02	Anode / VP-76	DI Discarded**
Anschlag 104-RH-04	06	Anschlag VP-104 3 Blatt	AP Approved
Anschlag VP64-04	08	Anschlag VP-64	AP Approved
Anschlag VP76-04	06	Anschlag v2.1 VP-76	AP Approved
Assembly DF-380-4bl-00	00	Assembly DF-380	AP Approved

Assembly Exploded_VP76-2bl-04	06	Assembly VP-76 v3.0/GL	AP Approved
Assembly FlgDF-380-50-00	00	Flügel DF-380	FI For Inf.
Assembly_Exploded VP-104-3bl-03	03	Assembly VP-104	AP Approved
Assembly_Exploded-GP-107-3bl	-	Assembly_Exploded GP-107-3blade-19	AP Approved
Assembly_VP64-04_exploded-01	12	Assembly VP-64 v3.0/GL	AP Approved
Assembly-1 DF-380-50-00 sh.1	00	Assembly DF-380	AP Approved
Assembly-2 DF-380-50-00 sh.2	00	Assembly DF-380	AP Approved
Assembly-3 DF-380-50-00 sh.3	00	Assembly DF-380	AP Approved
Assembly-GP-80-3bl	-	Assembly_Exploded-GP-80-3bl	AP Approved
Connect-plate-05	07a	Connecting Plate v3.0/GL VP-64	AP Approved
Connect-plate-VP104-04	04/GL	Connecting Plate VP-104	AP Approved
Connect-plate-VP76-05	07a	Connecting plate v3.0/GL VP-76	AP Approved
DF380_Flg-62-00-flat	2008-07-09	DF380_Flg-62-00 VariProp symm. section	AP Approved
DIN 913 - M30 x 120	00	Steigungsverstellungsschraube DF-380	FI For Inf.
FlgDF_schnitt-380-62-00	-	Flügelschnitt DF-380/48-62"	AP Approved
FlgDF-80GP-16	01	Flügel DF-80&107-GP/Serie	AP Approved
FlgGP-112-20-06a-flat	01	Flügel DF-112SE Vers.GP	AP Approved
FlgGP-112-20-06a-flat	-	Flügel DF-112_GP	AP Approved
FlgSchnitt-GP-112-20_24-01	2020-02-13	Flügelkontur DF-112 / dia. 20-24"	AP Approved
FlgVerzGP-112-01	01	Flügel-Zahnrad GP-112	AP Approved
Flg-VP104-Schnitt-26-00	00	Flügelschnitt VP-104 26"	AP Approved
Flg-VP104-Schnitt-26-01	00	Flügelschnitt VP-104 26"	AP Approved
GearAc_1818-04aRH	07	Nabenverzahnung VP-64 v3.0/GL	AP Approved
GearAc_2424-04RH	04	Nabenverzahnung VP-76 v3.0	AP Approved
GearAc_2727-03RH	03	Nabenverzahnung VP-104	AP Approved
GearPas_1818-02aLH	06	Flügelverzahnung VP-64 v3.0/GL	AP Approved
GearPas_2424-03LH	05	Flügelverzahnung VP-76 v3.0	AP Approved
GearPas_2727-01LH	03a	Flügelverzahnung VP-104	AP Approved
Geob104-3bl-00	01	VP-104 3 Blatt Gehäuse Oberteil	AP Approved
Geob112_GP-3bl	00	DF-112_GP 3 Blatt Gehäuse Oberteil	AP Approved
Geob112_GP-4bl	00	DF-112_GP 4 Blatt Gehäuse Oberteil	AP Approved
Geob380-4bl-01	01	Gehäuse-Oberteil 4 Blatt DF-380	AP Approved
Geob64-2bl-02	06	VP-64 2 Blatt Gehäuse Oberteil	AP Approved
Geob64-3bl-02	07	VP-64 3 Blatt Gehäuse Oberteil	AP Approved
Geob76-2bl-01	07	VP-76 2 Blatt Gehäuse Oberteil	AP Approved
Geob76-3bl-01	05	VP-76 3 Blatt Gehäuse Oberteil	AP Approved
Geut104-3bl-02	03	VP-104 3 Blatt Gehäuse Unterteil	AP Approved
Geut112_GP-3bl	00	DF-112_GP 3 Blatt Gehäuse Unterteil	AP Approved
Geut112_GP-4bl	00	DF-112_GP 4 Blatt Gehäuse Unterteil	AP Approved
Geut112_SD-4bl	00	DF-112_SD 4 Blatt Gehäuse Unterteil SD	AP Approved
Geut112-3bl	01a	DF-112_GP/SD 3 Blatt Gehäuse Untert. SD	AP Approved
Geut380-4bl-Sundin	01	Gehäuse-Unterteil 4 Blatt DF-380	AP Approved
Geut64-2bl-01	06a	VP-64 2 Blatt Gehäuse Unterteil	AP Approved
Geut64-3bl-01	07a	VP-64 3 Blatt Gehäuse Unterteil	AP Approved
Geut76-2bl-01	06a	VP-76 2 Blatt Gehäuse Unterteil	AP Approved
Geut76-3bl-01	05a	VP-76 3 Blatt Gehäuse Unterteil	AP Approved
GP112-20_24-01	2020-02-13	Flügelkontur DF-112 / dia. 20-24"	AP Approved
GP112-20-06a_DNV	01	Assembly_Exploded_GP-112-3bl	AP Approved
GP112-24-01	2020-11-19	Flügelkontur DF-112 / dia. 24"	AP Approved
Hub-25_VP64-04a	06a	Hub-25 VP-64	AP Approved

Job Id: **262.1-034406-1**  
Certificate No: **TAM000017G**

Hub-30_VP64-03	05a	Hub-30 VP-64	AP Approved
Hub-30_VP76-02	04a	Hub-30 VP-76	AP Approved
Hub-45_VP104-02	02/GL	Hub-45 VP-104	AP Approved
Kappe DF-380-00	01	Kappe DF-380	FI For Inf.
Nabe DF-380-01	01	Nabe DF-380	AP Approved
NabeDF112-02	04	Nabe DF-112	AP Approved
PropNut DF-380-00	00	Prop.-Nut DF-380	FI For Inf.
Puller DF-380-00	00	Abzieher f. DF-380	DI Discarded**
VP104_Flg-20-01_flat	2009-02-11	Blade VP-104 20"	AP Approved
VP104_Flg-26-01_flat	2009-04-15	Blade VP-104 26"	AP Approved
VP64_Flg-13-03_flat	2008-05-16	Blade VP-64 13"	AP Approved
VP64_Flg-18-03_flat	2008-05-16	Blade VP-64 18"	AP Approved
VP76_Flg-17-01_flat	2008-06-10	Blade VP-76 17"	AP Approved
VP76_Flg-22-01_flat	2008-06-25	Blade VP-76 22"	AP Approved

## Tests carried out

None.

## Marking of product

Manufacturer's name or trademark. Type number designation.

## Periodical assessment

For retention of the Type Approval, a DNV GL surveyor shall perform an assessment after 2 years and after 3.5 years to verify that the conditions of the type approval are complied with. A renewal assessment will be performed at renewal of the certificate.

The objective of the Periodical Assessment is to verify that the conditions for the Type Approval are not altered since the Type Approval Certificate was issued. The main scope of the Periodical Assessment will normally include:

- Verification of the Type Approval applicant's production and quality system w.r.t. ensuring continued consistent production of the Type Approved products at the Type Approval applicant's own premises and at other companies that are given the responsibility for manufacturing of the products
- Review of the Type Approval documentation and that this is still used as basis for the production
- Review of possible changes to the design, the material and the performance of the product
- Verification of the product marking

In cases where the Type Approved product is manufactured at other companies, the Periodical Assessment shall verify that the Type Approval applicant has a quality control system for consistent production at their licensees/subcontractors. Furthermore Periodical Assessment shall be carried out randomly at these companies.

When a Type Approved product is manufactured at other companies, the Type Approval applicant takes the sole responsibility for the conformity of the product to the applicable requirements.

END OF CERTIFICATE.