



Manual for the Feathering Propeller

DF-210 4 blade model

Installation on the shaft	page 2
Operation	page 4
Pitch adjustment LH (left-hand rotation propeller)	page 5
Pitch adjustment RH (right-hand rotation propeller)	page 6
Defining and checking adjustments	page 7
Removing from the shaft	page 8
Servicing	page 9
Torque settings prop-nut	page 10

INSTALLATION on the shaft

The VARIPROP is delivered assembled, greased and ready for installation.

He may not be disassembled, otherwise the warranty claim goes out!

Before fitting the VARIPROP onto the shaft, check key and keyway in the propeller hub. Take care that the key is the proper dimension and that the hub slides completely onto the shaft (see below). Also check the nut on thread of the shaft before fitting the prop. If you can not screw the nut the complete length of the thread, because of a little damage to the thread, carefully use a triangle file to bring it down to a good fit. Remove the housing cap with zinc anode (2) and the nut (4). Fit the propeller onto the shaft strongly. Tighten the nut (4) with LOCTITE medium (blue) onto the shaft (torque-setting see page 10) and secure it with the lock pins (3). Fit the housing cap with anode (2).

Make sure that the propeller is always protected from electrolytic corrosion by changing the anode (2) latest every year! May not be necessary in freshwater. After the VARIPROP has been fitted properly check that the blades rotate freely from the forward stop to the reverse stop. The shock absorber function can be felt ! See servicing page 9.

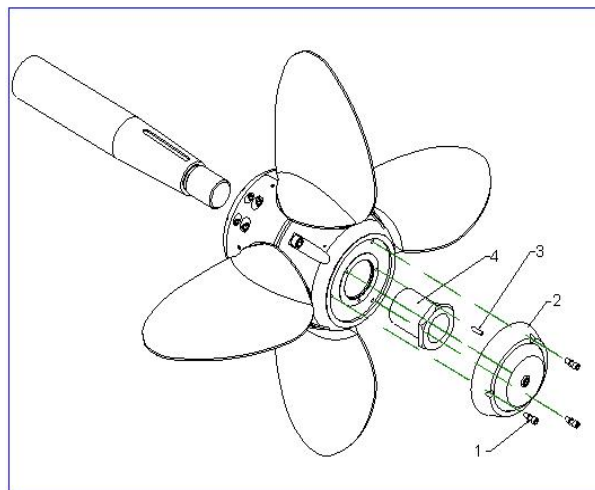

BLUE FIT CHECK of PROPELLER: The propellers are manufactured to close tolerances and therefore care must be taken when handling and mounting. Prior to mounting it may be necessary to check the blue fit of the propeller to guarantee a close fit to taper size. If the blue fit is unsatisfactory due to temperature differences it may be necessary to ream the propeller to suit. Therefore please use the grinding paste supplied with the propeller.

It must be noted however that all blue fits will have been 70 to 80% of the taper length.

MOUNTING: First slide the prop on the shaft without key. Mark the shaft with a grease-pen at the prop end. After tightening the shaft nut very strongly (torque-setting see page10) the mark must disappear. If not, the key is binding and the top or the sides of the key must be filed down. Light must be shining through on the top of the key when looking into the hub from astern. You may have to move your eye vertically to see it.

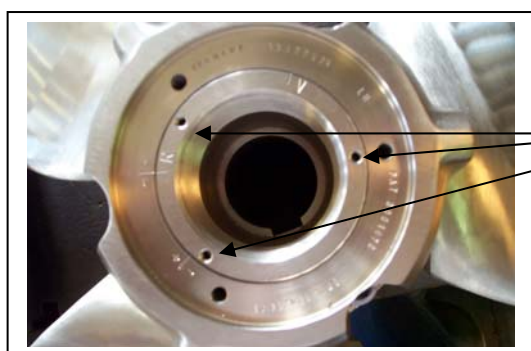

Only two of the three lock-pin holes can be used, depending on the final position of the shaft-nut flange (3).

Carefully align the lock-pins (3) straight. They must go in easily. If not, try first to tighten the propnut a little further until they do. If impossible, back off the nut a little. The lock-pins should be hand tightened only. If overtightened they may strip.

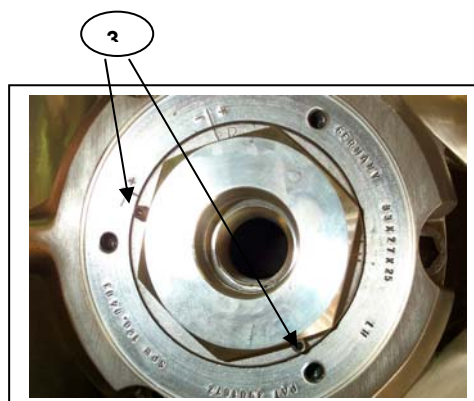

INSTALLATION on the shaft

ATTACHING THE HOUSING CAP with ZINC-ANODE:

First, insert all three housing cap screws (1, also page 8) loosely, then tighten securely in succession. Use LOCTITE low (pink) and observe the little washers.

ENGINE DRY TEST:

Please consider that a dry test of the engine **MUST NOT** be done while the VARIPROP is fitted onto the shaft ! The VARIPROP needs water pressure on the blades, otherwise the prop could be damaged !!

OPERATION

The VARIPROP feathers automatically when the shaft rotation is stopped. After engine start-up and shifting into gear the blades will engage in either forward or reverse.

THE BEST WAY TO FEATHER THE PROPELLER IN THE SAILPOSITION IS:

VARIPROP sailposition with mechanical gear-box:

- Power at 3 to 4 knots in forward.
- **Stop the engine, turn it off** and engage the transmission in reverse to stop the freewheeling of the shaft. Now engage in Neutral again.

VARIPROP sailposition with hydraulic transmission:

- Power at 3 to 4 knots in forward.
- Stop the engine while still engaged in forward. The remaining oil pressure of the transmission will stop spinning the shaft to feather the blades in the sailposition.

If the propeller is not feathered in the sailposition the shaft will freewheel like with a fixed propeller.

In that case start the engine again and repeat the steps above.

Once the prop is feathered, it is better to shift the transmission to neutral.

DO NOT stop the engine while it turns in reverse. In this case the blades will stay in the reverse position and will not feather. You can actually use this feature to drive a shaft generator.

Please note that 98% of our delivered VARIPROP propellers for hydrolic gear boxes feather into sailing position without a shaft lock as you turn off the engine with forward gear still clutched in. This procedure generates higher oil pressure and prevents shaft rotation. This small-scale friction is usually enough to feather the propeller instantly into sailing position. If this procedure does not work, you most likely need to fit a shaft lock. For large yachts, equipped with a propeller from our VARIPROP XLS range, we highly recommend to fit a shaft lock to ensure the propeller feathers and stays in sailing position.

TROUBLE SHOOTING: If the propeller does not work in forward or reverse go systematically through the points below:

- Check low idle of the engine. It should be 800 to 900 rpm in idle.
- Check shifting movement of the transmission lever. Make sure that the shifting travel is not too short. The amount of lever travel, as measured at the pivot point of the actuating lever, between the neutral position and end positions for forward and reverse can be found in the owners manual of your transmission. A larger amount of lever travel is in no way detrimental.
- Check the clutch discs of the transmission. They could be worn out.

WARNING: It is important to follow the instructions below carefully so as to avoid excessive load and shock to the gears, shortening their life.

- When going from ahead to astern or the opposite, it is necessary to idle down and shift at low rpm's (max.1200rpm) between gears to allow smooth reversing of rotation without binding. This will substantially lengthen the service life of your propeller gears.
When going from ahead to astern or the opposite, you can hear the turning-noise of the feathering blades. This is normal and not a problem or a defect of your VARIPROP.
- The propeller body must always be completely filled with a high viscosity grease. We recommend synthetic grease typ TW.2 GEL or mineral multi-purpose grease EP/SAL 8 (see servicing page 9)
- The propeller must be protected from electrolytic corrosion by fitting the usual zinc anodes on the shaft plus the prop anode. We recommend the replacement of the anode once a year.
- If you want to protect your VARIPROP with Antifouling, use only Antifouling which needs a primer first. Otherwise chemical interaction and decomposition could occur. Our recommendation is *Velox TF* including a primer (offers also protection against electrolyses), available from your VARIPROP distributor.

PITCH ADJUSTMENT „LH“

GENERAL: The pitch adjustment is very simple on the VARIPROP, and can be done in or out of the water in a matter of few minutes. It is not necessary to pull the propeller from the shaft.

Propeller in the drawing below is for a left hand rotation VARIPROP LH.

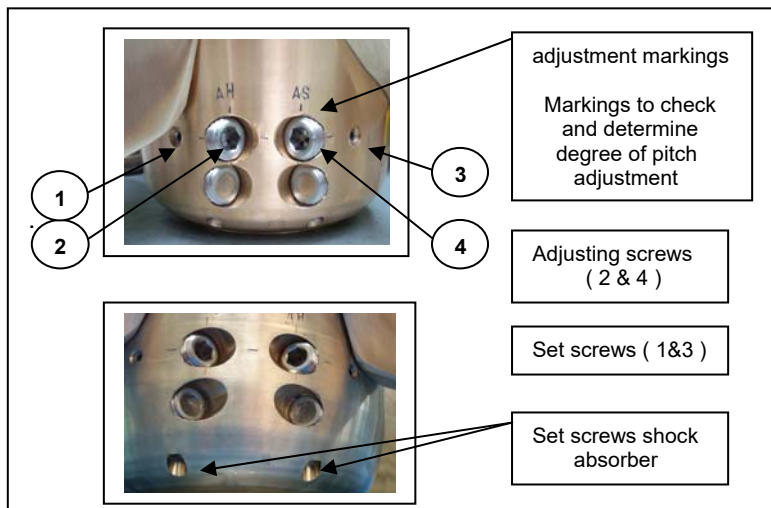

V= AH (Ahead)
R= AS (Asterm)

NOTE: It is quite possible to set the pitch continuously variable and independently for forward and reverse. The turning of the adjusting screws (2) & (4) by quarter a revolution (90°) changes the pitch approx. 1". This will change the engine revolution by approx. 125.

ATTENTION: **Never** remove the set screws of the shock absorber !!

The following description refers to the view towards astern for a left hand VARIPROP.

A. Adjusting the forward pitch:

1. Remove the set screw (1). Use the 4mm Allen-type key supplied with the prop.
2. Turn the adjusting screw (2) which is marked as "AH" or "V" with the 8mm Allen-key as follows:

2a. Increasing of pitch approx. 3" max.:

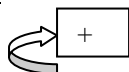

- Turn the adjusting screw (2) clockwise. (see "NOTE" above and page 7)
- Secure set screw (1) with LOCTITE low (pink) Lock set screw strongly.

2b. Reducing of pitch approx. 2" max.:

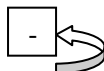

- Turn the adjusting screw (2) anti-clockwise. (see "NOTE" above and page 7).
- Secure set screw (1) with LOCTITE low (pink)
- Lock set screw strongly.

B. Adjusting the reverse pitch:

1. Remove the set screw (3). Use the 4mm Allen-type key supplied with the prop.
2. Turn the adjusting screw (4) which is marked as "AS" or "R" with the 8mm Allen-key as follows:

2a. Increasing of pitch approx. 2" max.:

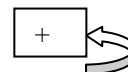

- Turn the adjusting screw (4) anti-clockwise. (see "NOTE" above and page 7)
- Secure set screw (3) with LOCTITE low (pink) Lock set screw strongly.

2b. Reducing of pitch approx. 3" max.:

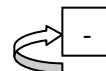

- Turn the adjusting screw (4) clockwise. (see "NOTE" above and page 7).
- Secure set screw (3) with LOCTITE low (pink).
- Lock set screw strongly.

PITCH ADJUSTMENT „RH“

GENERAL: The pitch adjustment is very simple on the VARIPROP, and can be done in or out of the water in a matter of few minutes. It is not necessary to pull the propeller from the shaft.

Propeller in the drawing below is for a right hand rotation RH.

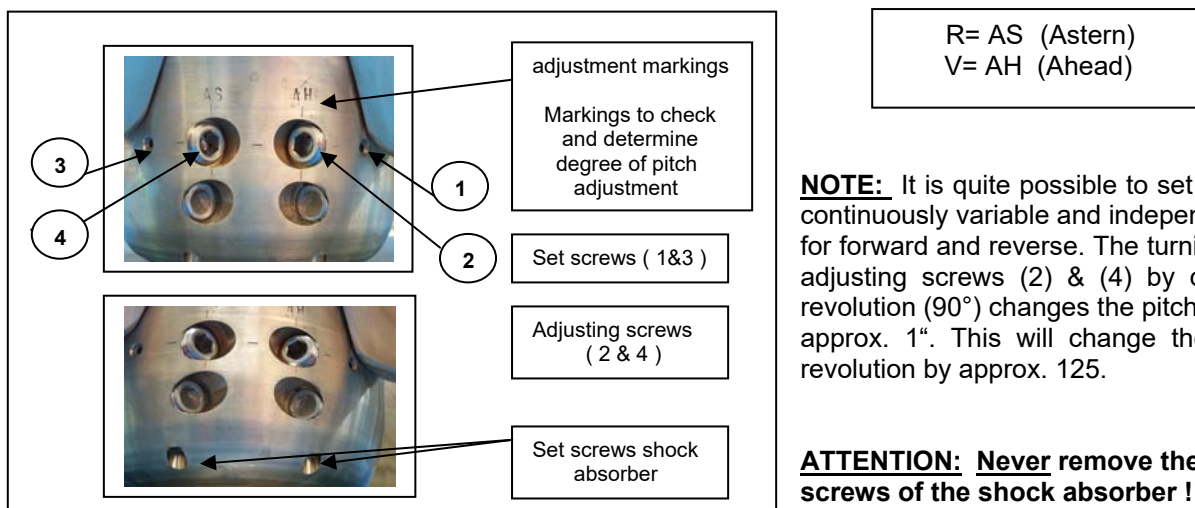

NOTE: It is quite possible to set the pitch continuously variable and independently for forward and reverse. The turning of the adjusting screws (2) & (4) by quarter a revolution (90°) changes the pitch approx. 1". This will change the engine revolution by approx. 125.

ATTENTION: Never remove the set screws of the shock absorber !!

The following description refers to the view towards astern for a right hand VARIPROP.

A. Adjusting the forward pitch :

1. Remove the set screw (1). Use the 4mm Allen-type key supplied with the prop.
2. Turn the adjusting screw (2) which is marked as "AH" or "V" with the 8mm Allen-key as follows:

2a. Increasing of pitch approx. 3" max.:

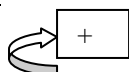

- Turn the adjusting screw (2) clockwise. (see "NOTE" above and page 7)
- Secure set screw (1) with LOCTITE low (pink).
- Lock set screw strongly.

2b. Reducing of pitch approx. 2" max.:

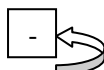

- Turn the adjusting screw (2) anti-clockwise. (see "NOTE" above and page 7).
- Secure set screw (1) with LOCTITE low (pink).
- Lock set screw strongly.

B. Adjusting the reverse pitch :

1. Remove the set screw (3). Use the 4mm Allen-type key supplied with the prop.
2. Turn the adjusting screw (4) which is marked as "AS" or "R" with the 8mm Allen-key as follows:

2a. Increasing of pitch approx. 2" max.:

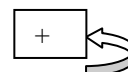

- Turn the adjusting screw (4) anti-clockwise. (see "NOTE" above note and page 7)
- Secure set screw (3) with LOCTITE low (pink).
- Lock set screw strongly.

2b. Reducing of pitch approx. 3" max.:

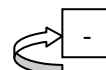

- Turn the adjusting screw (4) clockwise. (see "NOTE" above and page 7).
- Secure set screw (3) with LOCTITE low (pink).
- Lock set screw strongly.

Defining and checking pitch adjustments

It is quite possible to set the pitch continuously variable and independently for forward and reverse. The turning of the adjusting screws (2) & (4) at pages 5 & 6 by quarter a revolution (90°) changes the pitch approx. 1 ". That means a half turn (180°) changes the pitch by 2" etc..

For a check of pitch adjustments there are markings on the hub face under the housing cap.

To return to original factory pitch settings, line up "AH" or "V" resp. "AS" or "R" markings on the hub face.

Example:

check adjustments ahead

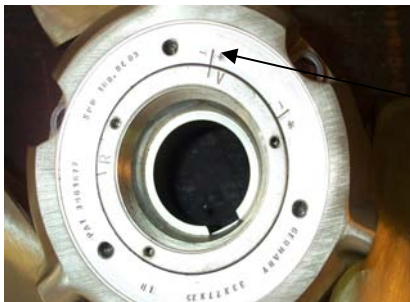

original factory pitch setting ahead

markings line up

inner marking has moved

plus



pitch has been increased ahead

check adjustments astern

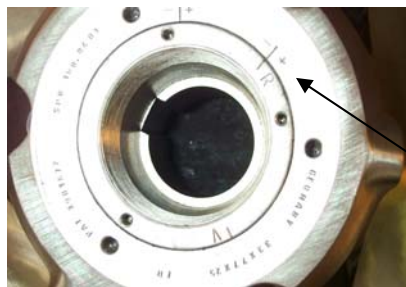

original factory pitch setting astern

markings lined up

inner marking has moved

minus



pitch has been decreased astern

NOTE :

- If the engine does not reach the desired RPM reduce the pitch.
- If the engine exceeds the desired RPM increase the pitch.
- 1" of pitch reduction / increase results in approx. 125 engine revolutions increase / reduction.

VARIPROP REMOVAL



The puller system is NOT included with the VARIPROP. It must be ordered separately.

The system includes only two parts :

- (1) The puller nut and
- (2) the hexagonal head bolt



1.) In order to remove the VARIPROP you must first remove the housing cap with zinc anode.

2.) Remove both lock pins (3) and the prop nut (4, see page 2)



3.) Screw the puller nut **completely** into the hub



4.) Now screw the hexagonal head bolt into the nut and turn the bolt against the shaft until the VARIPROP comes off the taper. Never use a hammer to remove the prop from the taper !

NOTE : Never dismantle the VARIPROP yourselves !!
Disassembly and reassembly require special tools and technical know-how only available at the factory or their approved service centres.

SERVICING

The VARIPROP needs to be greased up a minimum of every 2 – 3 years, depending on the engine hours run, or whenever the boat is hauled. The VARIPROP body should always be completely filled with a high viscosity **grease** of a hydrophobic nature. Remove the cap screw (5) and screw in the lubricating nipple which is supplied with the tools. Remove the “grease out” screw (6). During filling with grease rotate the propeller from forward stop to reverse stop to allow the grease to work through the propeller. Stop to pump when grease comes out at the opened “grease out “ port.

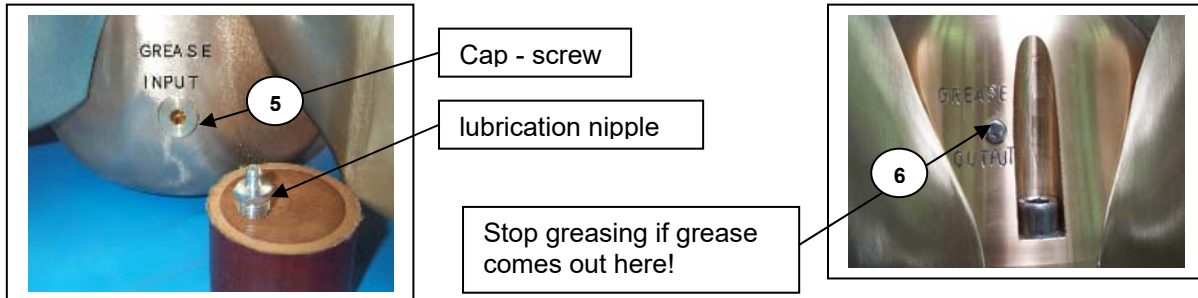

Factory supplied special grease EP/SAL is recommended and available from your VARIPROP distributor.
Avoid regular white grease (sterntube-grease) !

Shock-absorber: The integrated hydraulic shock-absorber reduces unpleasant operating noises. The pitch stops are substantially protected against wear. At rotating the blades by hand, you can feel the shock-absorber function. This “heavy” turning at the absorber area is normal and necessary for the function !

Zinc anode: Make sure that you always keep the zinc anode in good condition. The VARIPROP must be protected by a lot of zinc, so also use a zinc anode onto the shaft if possible. Use fine sandpaper to clean the aft of the end boss and the forward face of the VARIPROP-anode to give the zinc good contact with the propeller.

Tools supplied with your VARIPROP DF-210:



- 1x Manual
- 1x puller system (optional, must be ordered separately)
- 1x allen key 3mm
- 1x allen key 4mm
- 1x allen key 6mm
- 1x allen key 10mm
- 1x grease nipple G1/4"
- 1x small plastic bottle with Loctite low (pink)

Torque settings for the prop-nut

(page2, Fig.1, part-no.4)

Standard – thread

M 20 x 2,5 BSW 3 / 4 “ – 10 UNC 3 / 4 “ - 10	125 Nm / 95 ft/lb
--	-------------------

UNC 7/8 “ - 9	160 Nm / 115 ft/lb
---------------	--------------------

M 24 x 3 BSW 1 “ - 8 UNC 1 “ - 8	210 Nm / 155 ft/lb
--	--------------------

M 27 x 3	315 Nm / 230 ft/lb
----------	--------------------

M 30 x 3,5 BSW 1 1/4“ - 7 BSW 1 1/8“ - 7 UNC 1 1/8” - 7	350 Nm / 255 ft/lb
--	--------------------

UNC 1 1/4” “ - 7	350 Nm / 255 ft/lb
------------------	--------------------

UNC 1 1/2“ - 6	390 Nm / 290 ft/lb
----------------	--------------------

Fine - thread

M 20 x 1,5 BSF 3 / 4 “ – 12 UNC 3 / 4 “ - 16	135 Nm / 100 ft/lb
--	--------------------

M 24 x 2 BSF 1 “ - 10 UNF 1 “ - 12	225 Nm / 165 ft/lb
--	--------------------

M 30 x 2	430 Nm / 315 ft/lb
----------	--------------------

M 36 x 3	490 Nm / 360 ft/lb
----------	--------------------

M 42 x 3	530 Nm / 390 ft/lb
----------	--------------------

SUBJECT TO TECHNICAL ALTERATIONS; ERRORS and MISPRINTS